

**30A, 200V Ultrafast Diode**

The RURP3020 is an ultrafast diode ( $t_{rr} < 45\text{ns}$ ) with soft recovery characteristics. It has a low forward voltage drop and is of planar, silicon nitride passivated, ion-implanted, epitaxial construction.

This device is intended for use as an energy steering/clamping diode and rectifier in a variety of switching power supplies and other power switching applications. Its low stored charge and ultrafast recovery with soft recovery characteristics minimize ringing and electrical noise in many power switching circuits, thus reducing power loss in the switching transistor.

Formally development type TA09645.

**Ordering Information**

| PART NUMBER | PACKAGE  | BRAND    |
|-------------|----------|----------|
| RURP3020    | TO-220AC | RURP3020 |

NOTE: When ordering, use the entire part number.

**Symbol**



**Features**

- Ultrafast with Soft Recovery . . . . . <45ns
- Operating Temperature . . . . . 175°C
- Reverse Voltage . . . . . 200V
- Avalanche Energy Rated

**Applications**

- Switching Power Supply
- Power Switching Circuits
- General Purpose

**Packaging**

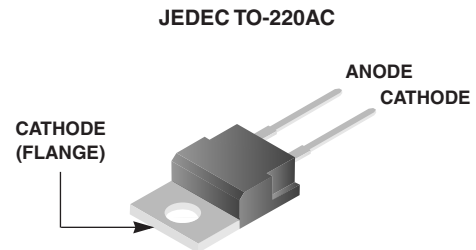

**Absolute Maximum Ratings**  $T_C = 25^\circ\text{C}$ , Unless Otherwise Specified

|  | RURP3020   | UNITS |
|--|------------|-------|
| Peak Repetitive Reverse Voltage . . . . . $V_{RRM}$                                      | 200        | V     |
| Working Peak Reverse Voltage . . . . . $V_{RWM}$   | 200        | V     |
| DC Blocking Voltage . . . . . $V_R$  | 200        | V     |
| Average Rectified Forward Current . . . . . $I_{F(AV)}$<br>( $T_C = 145^\circ\text{C}$ ) | 30         | A     |
| Repetitive Peak Surge Current . . . . . $I_{FRM}$<br>(Square Wave 20kHz)                 | 70         | A     |
| Nonrepetitive Peak Surge Current . . . . . $I_{FSM}$<br>(Halfwave 1 Phase 60Hz)          | 325        | A     |
| Maximum Power Dissipation . . . . . $P_D$  | 125        | W     |
| Avalanche Energy (See Figures 7 and 8) . . . . . $E_{AVL}$                               | 20         | mJ    |
| Operating and Storage Temperature . . . . . $T_{STG}, T_J$                               | -55 to 175 | °C    |

# RURP3020

## Electrical Specifications $T_C = 25^\circ\text{C}$ , Unless Otherwise Specified.

| SYMBOL          | TEST CONDITION  | MIN | TYP | MAX  | UNITS                     |
|-----------------|---|-----|-----|------|---------------------------|
| $V_F$           | $I_F = 30\text{A}$                                    | -   | -   | 1.0  | V                         |
|                 | $I_F = 30\text{A}, T_C = 150^\circ\text{C}$           | -   | -   | 0.85 | V                         |
| $I_R$           | $V_R = 200\text{V}$                                   | -   | -   | 250  | $\mu\text{A}$             |
|                 | $V_R = 200\text{V}, T_C = 150^\circ\text{C}$          | -   | -   | 1.0  | mA                        |
| $t_{rr}$        | $I_F = 1\text{A}, dI_F/dt = 100\text{A}/\mu\text{s}$  | -   | -   | 45   | ns                        |
|                 | $I_F = 30\text{A}, dI_F/dt = 100\text{A}/\mu\text{s}$ | -   | -   | 50   | ns                        |
| $t_a$           | $I_F = 30\text{A}, dI_F/dt = 100\text{A}/\mu\text{s}$ | -   | 20  | -    | ns                        |
| $t_b$           | $I_F = 30\text{A}, dI_F/dt = 100\text{A}/\mu\text{s}$ | -   | 15  | -    | ns                        |
| $R_{\theta JC}$ |   | -   | -   | 1.2  | $^\circ\text{C}/\text{W}$ |

### DEFINITIONS

$V_F$  = Instantaneous forward voltage ( $p_w = 300\mu\text{s}$ ,  $D = 2\%$ ).

$I_R$  = Instantaneous reverse current.

$t_{rr}$  = Reverse recovery time at  $dI_F/dt = 100\text{A}/\mu\text{s}$  (See Figure 6), summation of  $t_a + t_b$ .

$t_a$  = Time to reach peak reverse current at  $dI_F/dt = 100\text{A}/\mu\text{s}$  (See Figure 6).

$t_b$  = Time from peak  $I_{RM}$  to projected zero crossing of  $I_{RM}$  based on a straight line from peak  $I_{RM}$  through 25% of  $I_{RM}$  (See Figure 6).

$R_{\theta JC}$  = Thermal resistance junction to case.

$p_w$  = pulse width.

$D$  = duty cycle.

## Typical Performance Curves

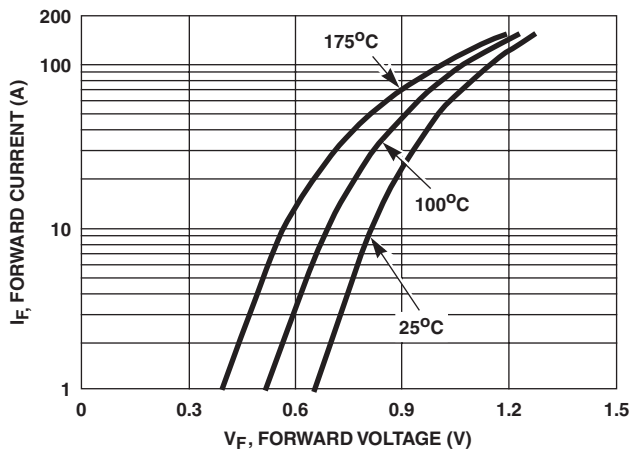

FIGURE 1. FORWARD CURRENT vs FORWARD VOLTAGE

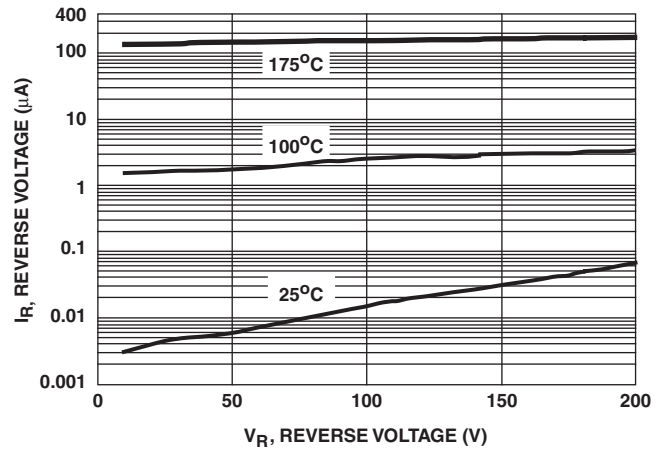

FIGURE 2. REVERSE CURRENT vs REVERSE VOLTAGE

Typical Performance Curves (Continued)

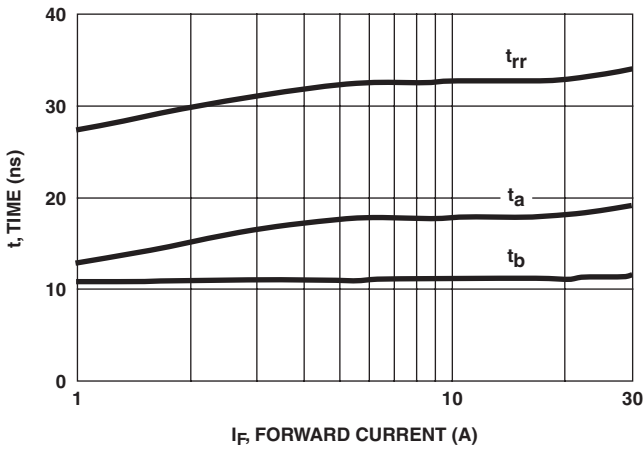

FIGURE 3.  $t_{rr}$ ,  $t_a$  AND  $t_b$  CURVES vs FORWARD CURRENT

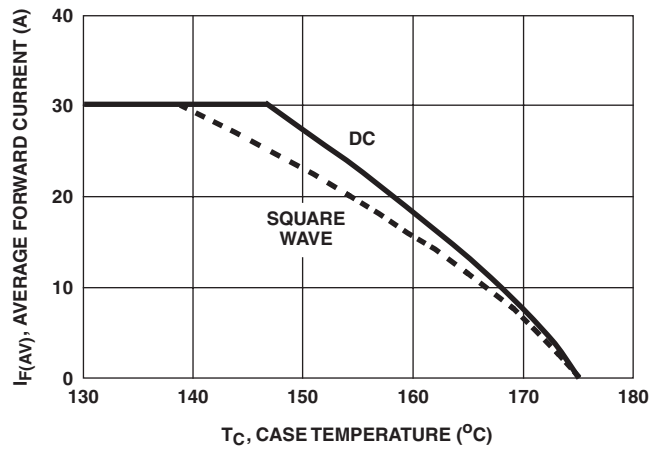

FIGURE 4. CURRENT DERATING CURVE

Test Circuits and Waveforms

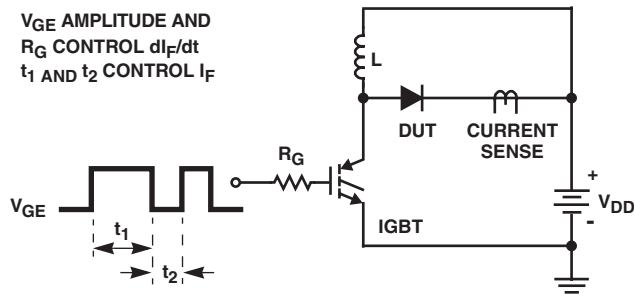

FIGURE 5.  $t_{rr}$  TEST CIRCUIT

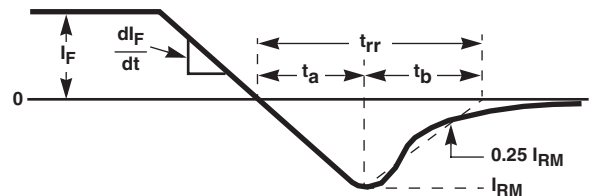

FIGURE 6.  $t_{rr}$  WAVEFORMS AND DEFINITIONS

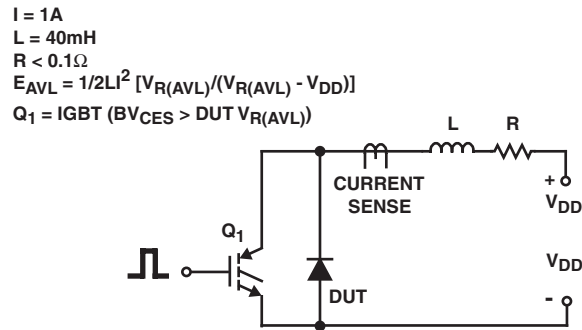

FIGURE 7. AVALANCHE ENERGY TEST CIRCUIT

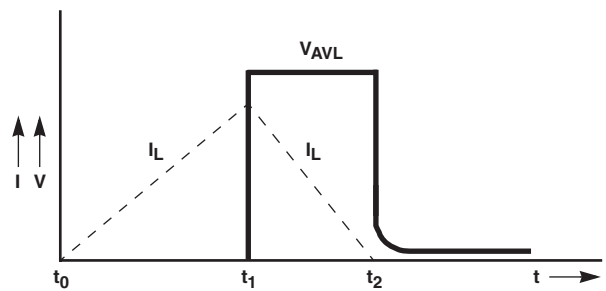

FIGURE 8. AVALANCHE CURRENT AND VOLTAGE WAVEFORMS

## TRADEMARKS

The following are registered and unregistered trademarks Fairchild Semiconductor owns or is authorized to use and is not intended to be an exhaustive list of all such trademarks.

|                                   |                                  |                                  |                              |                   |
|-----------------------------------|----------------------------------|----------------------------------|------------------------------|-------------------|
| ACE <sub>x</sub> <sup>TM</sup>    | FAST <sup>®</sup>                | OPTOLOGIC <sup>TM</sup>          | SMART START <sup>TM</sup>    | VCX <sup>TM</sup> |
| Bottomless <sup>TM</sup>          | FAST <sub>r</sub> <sup>TM</sup>  | OPTOPLANAR <sup>TM</sup>         | STAR*POWER <sup>TM</sup>     |                   |
| CoolFET <sup>TM</sup>             | FRFET <sup>TM</sup>              | PACMAN <sup>TM</sup>             | Stealth <sup>TM</sup>        |                   |
| CROSSVOLT <sup>TM</sup>           | GlobalOptoisolator <sup>TM</sup> | POP <sup>TM</sup>                | SuperSOT <sup>TM</sup> -3    |                   |
| DenseTrench <sup>TM</sup>         | GTO <sup>TM</sup>                | Power247 <sup>TM</sup>           | SuperSOT <sup>TM</sup> -6    |                   |
| DOMET <sup>TM</sup>               | HiSeC <sup>TM</sup>              | PowerTrench <sup>®</sup>         | SuperSOT <sup>TM</sup> -8    |                   |
| EcoSPARK <sup>TM</sup>            | ISOPLANAR <sup>TM</sup>          | QFET <sup>TM</sup>               | SyncFET <sup>TM</sup>        |                   |
| E <sup>2</sup> CMOS <sup>TM</sup> | LittleFET <sup>TM</sup>          | QS <sup>TM</sup>                 | TinyLogic <sup>TM</sup>      |                   |
| EnSigna <sup>TM</sup>             | MicroFET <sup>TM</sup>           | QT Optoelectronics <sup>TM</sup> | TruTranslation <sup>TM</sup> |                   |
| FACT <sup>TM</sup>                | MicroPak <sup>TM</sup>           | Quiet Series <sup>TM</sup>       | UHC <sup>TM</sup>            |                   |
| FACT Quiet Series <sup>TM</sup>   | MICROWIRE <sup>TM</sup>          | SILENT SWITCHER <sup>®</sup>     | UltraFET <sup>®</sup>        |                   |

STAR\*POWER is used under license

## DISCLAIMER

FAIRCHILD SEMICONDUCTOR RESERVES THE RIGHT TO MAKE CHANGES WITHOUT FURTHER NOTICE TO ANY PRODUCTS HEREIN TO IMPROVE RELIABILITY, FUNCTION OR DESIGN. FAIRCHILD DOES NOT ASSUME ANY LIABILITY ARISING OUT OF THE APPLICATION OR USE OF ANY PRODUCT OR CIRCUIT DESCRIBED HEREIN; NEITHER DOES IT CONVEY ANY LICENSE UNDER ITS PATENT RIGHTS, NOR THE RIGHTS OF OTHERS.

## LIFE SUPPORT POLICY

FAIRCHILD'S PRODUCTS ARE NOT AUTHORIZED FOR USE AS CRITICAL COMPONENTS IN LIFE SUPPORT DEVICES OR SYSTEMS WITHOUT THE EXPRESS WRITTEN APPROVAL OF FAIRCHILD SEMICONDUCTOR CORPORATION.

As used herein:

1. Life support devices or systems are devices or systems which, (a) are intended for surgical implant into the body, or (b) support or sustain life, or (c) whose failure to perform when properly used in accordance with instructions for use provided in the labeling, can be reasonably expected to result in significant injury to the user.
2. A critical component is any component of a life support device or system whose failure to perform can be reasonably expected to cause the failure of the life support device or system, or to affect its safety or effectiveness.

## PRODUCT STATUS DEFINITIONS

### Definition of Terms

| Datasheet Identification | Product Status         | Definition  |
|--------------------------|------------------------|---|
| Advance Information      | Formative or In Design | This datasheet contains the design specifications for product development. Specifications may change in any manner without notice.  |
| Preliminary              | First Production       | This datasheet contains preliminary data, and supplementary data will be published at a later date. Fairchild Semiconductor reserves the right to make changes at any time without notice in order to improve design. |
| No Identification Needed | Full Production        | This datasheet contains final specifications. Fairchild Semiconductor reserves the right to make changes at any time without notice in order to improve design.   |
| Obsolete                 | Not In Production      | This datasheet contains specifications on a product that has been discontinued by Fairchild semiconductor. The datasheet is printed for reference information only.   |